

SITAGGO 2.0



SITAG
by Nowy Styl



SITAGGO 2.0

| D | **DIE NEUE GENERATION** der höhenverstellbaren Tische SITAGGO 2.0 bietet perfekte Lösungen. Er ermöglicht seinen Nutzern flexibel zwischen sitzenden und stehenden Arbeitspositionen zu wechseln – jederzeit und ohne Anstrengung. Gesundheit und Produktivität profitieren davon!

| E | **THE NEW GENERATION** of height-adjustable SITAGGO 2.0 desks offers perfect solutions. It enables its users to flexibly change between sitting and standing work positions – at all times and without strenuous effort. Health and productivity profit from SITAGGO 2.0.

| F | **LA NOUVELLE GÉNÉRATION** de tables réglables en hauteur SITAGGO 2.0 offre des solutions parfaites. Elle permet à ses utilisateurs de passer aisément de la position assise à la position debout, à tout moment et sans effort. La santé et la productivité en profitent !

| I | **LA NUOVA GENERAZIONE** di scrivanie ad altezza regolabile SITAGGO 2.0 offre soluzioni perfette permettendo ai suoi utenti di passare con flessibilità da seduti a in piedi e viceversa, in qualsiasi momento e senza alcuno sforzo. A beneficiarne saranno sia la salute che la produttività!



|E| HEIGHT-ADJUSTABLE DESKS
ARE ESSENTIAL FOR ERGONOMIC
AND EFFECTIVE WORK

|F| LES TABLES RÉGLABLES EN
HAUTEUR SONT INDISPENSABLES
POUR UN TRAVAIL ERGONOMIQUE ET
EFFICACE

|I| SCRIVANIE REGOLABILI IN
ALTEZZA SONO IRRINUNCIABILI PER
CHI VUOLE LAVORARE IN MODO
ERGONOMICO ED EFFICACE

HÖHENVERSTELLBARE ARBEITSTISCHE SIND UNVERZICHTBAR FÜR ERGONOMISCHES UND EFFEKTIVES ARBEITEN



SITAGGO 2.0 ARBEITSTISCH

| E | SITAGGO 2.0 DESK
| F | SITAGGO 2.0 BUREAU
| I | SCRIVANIA SITAGGO 2.0

SITAGGO 2.0: sein klares Design, sein optimales Zubehör und der attraktive Preis machen den Solotisch mit reduzierten Funktionen zum Einstiegsmodell in die Welt des ergonomischen Arbeitens. Ausgestattet mit einer elektrischen Höhenregulierung kann SITAGGO sowohl als Sitz- als auch als Steharbeitsplatz genutzt werden.



| E | **SITAGGO 2.0:** Its clean design, its optimal accessories, and an attractive price make this solo desk, with essential functions, an ideal entry-level model into the world of ergonomic work. Equipped with electrically powered height adjustment, SITAGGO 2.0 can be used as a sitting or as a standing workplace.

| F | **SITAGGO 2.0 :** Son design sobre, ses accessoires idéaux et son prix attrayant font de cette table solitaire aux fonctions réduites à l'essentiel la solution d'entrée de gamme dans le monde du travail ergonomique. Réglable en hauteur par moteur électrique, SITAGGO 2.0 s'utilise aussi bien sous forme de poste de travail assis que sous forme de poste de travail debout.

| I | **SITAGGO 2.0:** Un design chiaro e lineare, accessori ottimali e un prezzo allettante fanno di questa scrivania singola, con funzioni ridotte, un modello ideale per chi vuole passare ad un modo di lavorare ergonomico senza spendere troppo. Dotato di una funzione di regolazione altezza elettrica, SITAGGO 2.0 si potrà usare sia da seduti che in piedi.



| D | AUCH IM HOME OFFICE spielt Ergonomie eine wichtige Rolle. Dazu gehört neben einem funktionalen Bürostuhl auch ein ergonomischer, höhenverstellbarer Arbeitstisch. Durch die grosse Auswahl an Größen, Farben und Oberflächen passt er sich an jedes Ambiente an.

| E | IN THE HOME OFFICE AS WELL, ergonomics plays an essential role. In addition to an efficient office chair, this also includes an ergonomic, height-adjustable desk. A wide selection of sizes, colours and surfaces means that such furniture can effectively match any office surrounding.

| F | POUR LE TRAVAIL À DOMICILE AUSSI, l'ergonomie joue un rôle important. Outre une chaise de bureau fonctionnelle, elle nécessite également un poste de travail ergonomique et réglable en hauteur. Grâce à son large choix de tailles, de couleurs et de surfaces, il s'adapte à toutes les ambiances.

| I | ANCHE IN HOME OFFICE l'ergonomia ha un ruolo importante. Oltre ad una sedia funzionale, è necessaria in questo senso anche una scrivania ergonomica ad altezza regolabile. Grazie alla grande scelta di misure, colori e finiture, SITAGGO si adatta ad ogni ambiente.



SITAGGO 2.0 KONFERENZTISCH

| E | SITAGGO 2.0 CONFERENCE TABLE
| F | SITAGGO 2.0 TABLE DE CONFÉRENCE
| I | TAVOLO DA RIUNIONI SITAGGO 2.0

| D | DIE HÖHENVERSTELLBAREN KONFERENZTISCHE von SITAGGO 2.0 schaffen nicht nur Orte für eine kurze informelle Besprechungen im Stehen, sondern auch für formelle längere Meetings, die eine bequeme Sitzposition erfordern.

| E | SITAGGO 2.0 HEIGHT-ADJUSTABLE conference tables create not only a place for short, informal meetings in standing – but also for formal, longer meetings that require comfortable sitting.

| F | LA TABLE DE CONFÉRENCE RÉGLABLE SITAGGO 2.0 permet non seulement d'aménager des lieux pour de courtes réunions informelles en position debout, mais aussi pour des réunions formelles plus longues qui requièrent une assise confortable.

| I | I TAVOLI DA RIUNIONI ad altezza regolabile della linea SITAGGO 2.0 creano una piattaforma non solo per brevi riunioni o colloqui informali in piedi ma anche per meeting più lunghi con carattere ufficiale, durante i quali i presenti dovranno poter sedere con comodità.



SITAGGO 2.0 WORKBENCH

| D | DIE WORKBENCH fördert Kommunikation und Interaktion. Teammitglieder können zwischen Sitzen und Stehen wechseln, ohne den Augenkontakt oder den Arbeitsfluss zu unterbrechen, behalten aber den eigenen, komfortablen Bereich für die Ausführung individueller Aufgaben. Einsetzbar in unterschiedlichen Zonen und Bereichen – wie Team- und Projektarbeit, Desk-Sharing oder als klassischer Arbeitstisch.

| E | THE SITAGGO 2.0 WORKBENCH promotes good communication and interaction. Team members can change back and forth between sitting and standing – without interrupting eye contact or their workflow. At the same time, they keep their own comfortable area for taking care of individual assignments. For use in various zones and areas: such as team and project work, desk sharing – or as a classic desk.

| F | LE SITAGGO 2.0 WORKBENCH favorise la communication et l'interaction. Les membres de l'équipe peuvent passer de la position assise à la position debout sans interrompre le contact visuel ou le déroulement du travail, mais conservent leur propre espace confortable pour l'exécution des tâches individuelles. Il peut être utilisé dans différentes zones et différents domaines – comme le travail en équipe et en projet, les espaces partagés ou en tant que bureau classique.

| I | SITAGGO 2.0 WORKBENCH favorisce la comunicazione e l'interazione. I membri del gruppo di lavoro possono passare da seduti a in piedi e viceversa senza interrompere la conversazione o il flusso lavorativo mantenendo però la propria comodità nello svolgimento dei compiti individuali. Questa soluzione può essere utilizzata in varie zone e settori, come ad esempio nel lavoro di progetto e di gruppo, per modelli di desk sharing o come classica scrivania.



SITAGGO 2.0: FLEXIBEL UND VIELSEITIG

| E | SITAGGO 2.0: FLEXIBLE AND VERSATILE | F | SITAGGO 2.0: FLEXIBLE ET POLYVALENT | I | SITAGGO 2.0: FLESSIBILE E VERSATILE



SITAGGO 2.0: DIE AUSSTATTUNG

| E | SITAGGO 2.0: FEATURES | F | SITAGGO 2.0: L'ÉQUIPEMENT | I | SITAGGO 2.0: L'EQUIPAGGIAMENTO



| D | **HÖHENVERSTELLUNG** im Bereich von 65 – 130 cm.

| E | **HEIGHT ADJUSTMENT** in the range of 65 – 130 cm.

| F | **RÉGLAGE DE LA HAUTEUR** selon une plage comprise entre 65 et 130 cm.

| I | **REGOLAZIONE ALTEZZA** nella gamma 65 – 130 cm.



| D | **DIE VERSTELLGESCHWINDIGKEIT** von 38 mm/s ermöglicht eine komfortable und schnelle Anpassung.

| E | **THE HEIGHT-ADJUSTMENT SPEED** of 38 mm/s enables fast and convenient adjustments.

| F | **LA VITESSE D'AJUSTEMENT** de 38 mm/s permet un réglage confortable et rapide.

| I | **LA VELOCITÀ DI REGOLAZIONE** di 38 mm/s permette di impostare l'altezza desiderata in modo rapido e confortevole.

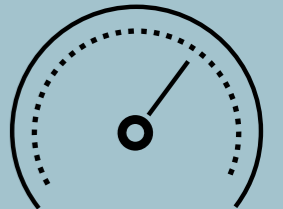

38mm/s

| D | **BELASTBARKEIT** der Tischplatte bis 100 kg.

| E | **LOAD-CARRYING CAPACITY** of the desktop up to 100 kg.

| F | **CAPACITÉ DE CHARGE** du plateau de table allant jusqu'à 100 kg.

| I | **CARICO MASSIMO SOSTENIBILE** per il piano della scrivania/del tavolo: 100 kg.

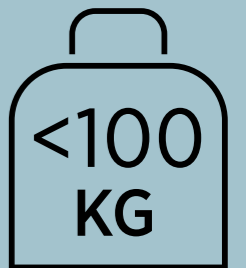

| D | **ALS OPTION** ist SITAGGO 2.0 auch mit einem (auch nachträglich montierbaren) **Kabelkanal** lieferbar.

| E | **AS OPTION**, SITAGGO 2.0 is also available with cable trunking (which can also be retrofitted).

| F | **EN OPTION**, SITAGGO 2.0 est également disponible avec un passe-câbles (dont le montage peut se faire ultérieurement).

| I | **COME OPZIONE**, SITAGGO 2.0 è disponibile anche con un canale portacavi (montabile anche a posteriori).



| D | **DOPPELARBEITSPLATZ** mit optionalem **Sichtschutz-Paneel**.

| E | **DOUBLE WORKPLACE** with an optional desk privacy partition.

| F | **DOUBLE POSTE DE TRAVAIL** avec paroi de protection visuelle en option.

| I | **POSIZIONE DI LAVORO DOPPIA** con opzionale pannello paravista.



GERÄUSCHLOS

| E | SILENT | F | SILENCIEUX | I | SILENZIOSO



| D | **FLÜSTERLEISE** Verstellung (unter 45 dB).

| E | **WHISPER-QUIET** (below 45 dB).

| F | **RÉGLAGE EXTRÊMEMENT SILENCIEUX** (au-dessous de 45 dB).

| I | **REGOLAZIONE SILENZIOSA COME UN SUSSURRO** (< 45 dB).

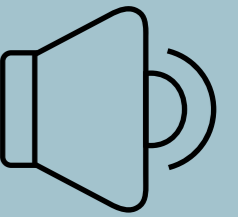

<45 dB

| D | **KRAFTVOLL** – jede Säule ist mit einem Motor ausgestattet.

| E | **POWERFUL** – each desk leg is fitted with a motor.

| F | **PUISSANT** – chaque colonne est équipée d'un moteur.

| I | **POTENTE**: ogni colonna è dotata di un motore.

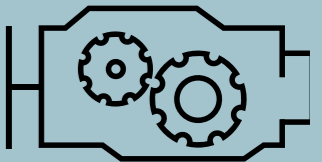

2x

| D | **DER AUFFAHRSSCHUTZ** erkennt, wenn die Tischplatte auf ein stabiles Hindernis trifft. Die Tischplatte stoppt und fährt in eine sichere Position zurück. Optional kann ein hochsensibler externer Gyro-Sensor eingesetzt werden.

| E | **THE COLLISION-PROTECTION FEATURE**, detects when the tabletop hits a stable obstacle. The tabletop stops and moves back into a safe position. Optionally, a highly sensitive external gyro sensor can be used.

| F | **LA PROTECTION ANTI-COLLISION** détecte lorsque le plateau de table rencontre un obstacle stable. Le plateau de table s'arrête et revient dans une position sûre. Un capteur gyroscopique externe très sensible peut être utilisé en option.

| I | **LA PROTEZIONE ANTI-IMPATTO** in salita riconosce quando il piano della scrivania/ del tavolo incontra un ostacolo solido. In tal caso il piano arresta la salita tornando in una posizione sicura. In alternativa, è possibile utilizzare un sensore giroscopico esterno ad alta sensibilità.

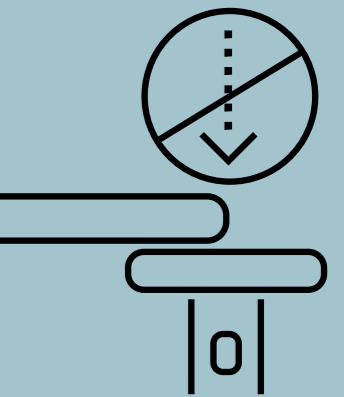

| D | **EINE 4-FACH PROGRAMMIERBARE KOMFORT-SCHALTUNG** ist optional lieferbar.

| E | **A QUADRUPLE PROGRAMMABLE CONVENIENCE SWITCH** is available as option.

| F | **UN DISPOSITIF À 4 RÉGLAGES**, facilement programmable, est disponible en option.

| I | **UN SISTEMA DI REGOLAZIONE COMFORT PROGRAMMABILE** su 4 livelli è disponibile come optional.



| D | **EINE SCHIEBEPLATTE** ist als Option erhältlich.

| E | **A SLIDING DESKTOP** is available as an option.

| F | **UN PLATEAU COULISSANT** est disponible en option.

| I | **UN PIANO SCORREVOLE** è disponibile come optional.

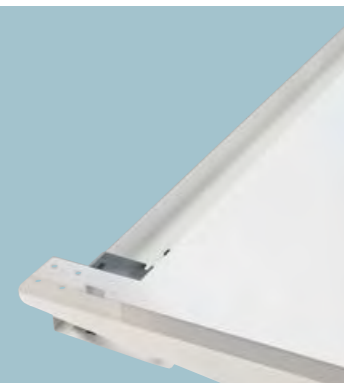

AUSSTATTUNGSMÖGLICHKEITEN

| E | AVAILABLE FEATURES
| F | OPTIONS D'ÉQUIPEMENT
| I | OPZIONI DI EQUIPAGGIAMENTO



| D | Sichtrückwand Lochblech (optional)
| E | Rear privacy panel, made of perforated sheet metal (optional)
| F | Protection visuelle arrière en tôle perforée (en option)
| I | Pannello a vista rivestito in lamiera perforata (optional)

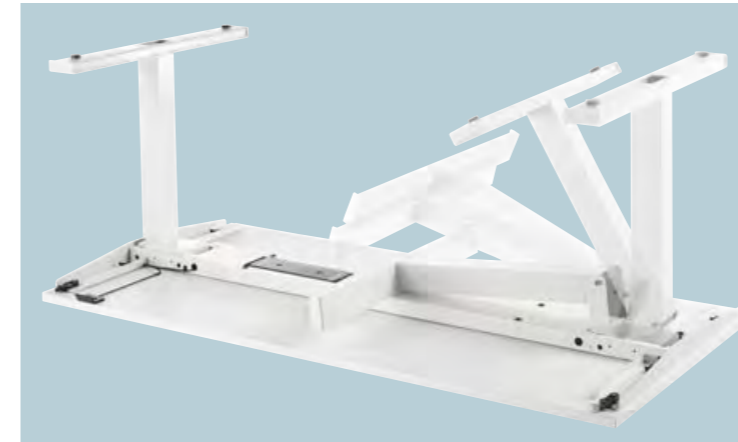

| D | Einklappbares Fussgestell (Montage mit Inbusschlüssel), Auslieferung ab Werk aufgebaut, auf Wunsch platzsparend zusammengeklappt
| E | Fold-down leg frame (assembled with an Allen spanner), delivered fully assembled ex works, but delivered folded together if requested to save room
| F | Piètement pliable (montage avec clé Allen), livraison départ usine assemblée, ou repliée sur demande pour gagner de la place
| I | Basamento ripiegabile (da montare con chiave a brugola), consegna franco fabbrica già allestito, su richiesta ripiegato per occupare meno spazio



| D | Aufsatzwand light
| E | Attached panel, light version
| F | Paroi de séparation light
| I | Pannello applicabile light



| D | Up/Down Handschalter
| E | Up/down hand switch
| F | Interrupteur manuel haut/bas
| I | Pulsante manuale up/down



| D | Schiebepatte mit integriertem horizontalen Kabelkanal (optional)
| E | Sliding tabletop with integrated horizontal cable trunking (as option)
| F | Panneau coulissant avec passe-câbles horizontal intégré (en option)
| I | Piano scorrevole con canale portacavi orizzontale integrato (optional)



| D | Up/Down Handschalter mit Display und Memory-Funktion
| E | Up/down hand switch with display and memory function
| F | Commutateur manuel haut/bas avec affichage et fonction mémoire
| I | Pulsante manuale up/down con display e funzione memoria



| D | Vertikaler Kabelkanal mit Magnet an der Tischplatte oder am horizontalen Kabelkanal befestigt (optional)
| E | Vertical cable trunking with magnet on the desktop or on horizontal cable trunking (as option)
| F | Passe-câbles vertical fixé sur la table avec un aimant ou sur un passe-câbles horizontal (en option)
| I | Canale portacavi verticale, fissato con magnete al piano della scrivania o al canale orizzontale (optional)



| D | Sichtschutz an der SITAGGO 2.0 Workbench
| E | Desk privacy partition for the SITAGGO 2.0 workbench
| F | Protection visuelle sur le SITAGGO 2.0 Workbench
| I | Protezione paravista su SITAGGO 2.0 Workbench

VARIANTEN

| E | VARIANTS
| F | VARIANTES
| I | VARIANTI

ARBEITSTISCHE:

| E | DESKS | F | POSTE DE TRAVAIL | I | SCRIVANIE

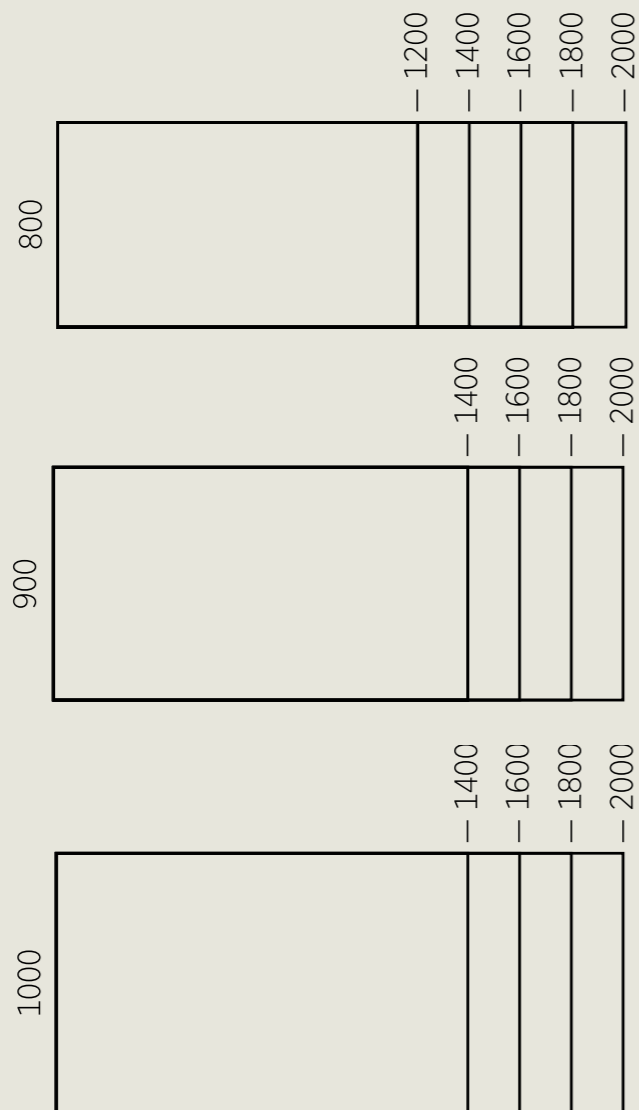

WORKBENCH:

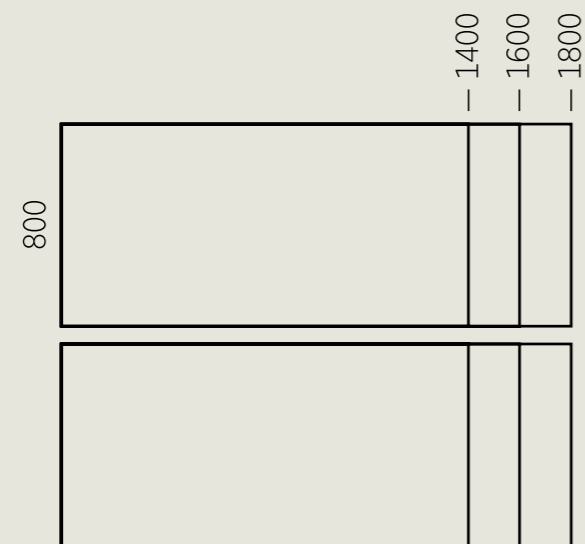

BESPRECHUNGS- UND KONFERENZTISCHE:

| E | DISCUSSION AND CONFERENCE TABLES | F | TABLE DE RÉUNION ET DE CONFÉRENCE | I | TAVOLI PER RIUNIONI E COLLOQUI

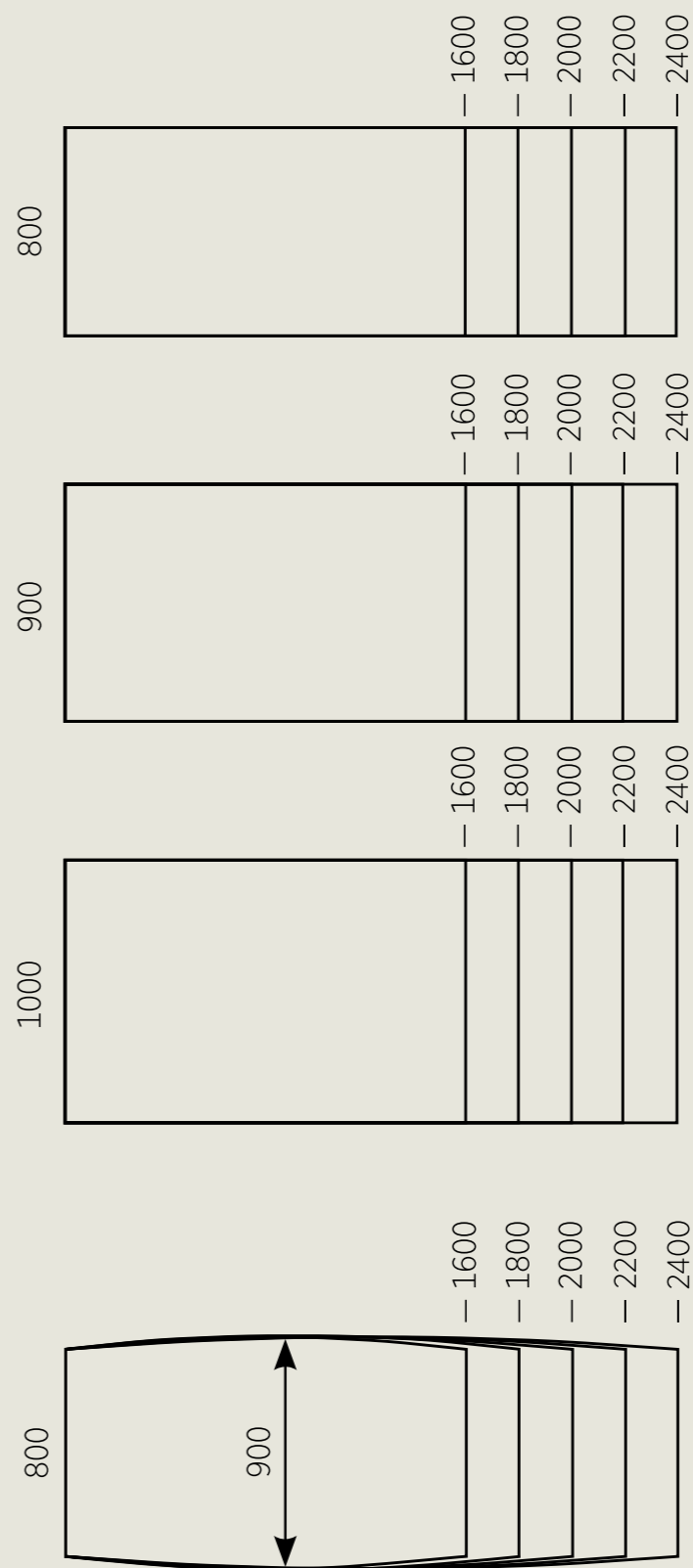

R 60 mm

| D | Alle Tischplatten optional auch mit gerundeten Ecken (60 mm Radius).

| E | All desktops are also optionally available with rounded corners (60 mm radius).

| F | Tous les plateaux de table peuvent également, en option, avoir des coins arrondis de 60 mm de rayon.

| I | Tutti i piani della scrivania disponibili in via opzionale anche con angoli smussati ad un raggio di 60 mm.

SITAGGO 2.0 MINI

| D | **SITAGGO 2.0 MINI** bietet viele Funktionen in komprimierter Form. Das klare Design und die Mobilität des Schreibtisches ermöglichen nicht nur eine schnelle Anpassung an den Arbeitsstil, sondern auch an die jeweilige Raumsituation. Arbeiten Sie nach dem Agile-Working-Konzept? Oder vielleicht im Home Office? Dank der elektrischen Höhenverstellung ist SITAGGO 2.0 MINI jeder Aufgabe gewachsen und sorgt für mehr Bewegung und Arbeitskomfort.

| E | **THE SITAGGO 2.0 MINI** offers many functions in compact form. The clean design and the mobility of this desk enable fast adaptation not only to your working style, but also to the respective room situation. Do you work according to the Agile Working Concept? Or perhaps in a home office? Thanks to its electric height adjustment, the SITAGGO 2.0 MINI fulfils every task and enables more movement and working comfort.

| F | **SITAGGO 2.0 MINI** offre de nombreuses fonctions sous forme compacte. Le design épuré et la mobilité du bureau permettent non seulement une adaptation rapide au style de travail, mais aussi à l'aménagement de la pièce concernée. Êtes-vous adepte du concept Agile-? Ou peut-être restez-vous à domicile, en télétravail ? Grâce au réglage électrique de la hauteur, SITAGGO 2.0 MINI convient à toutes les tâches et offre plus de mouvement et de confort de travail.

| I | **SITAGGO 2.0 MINI** offre molte funzioni in forma concentrata. Il design chiaro e lineare, come anche la mobilità della scrivania permettono un rapido adeguamento non solo allo stile di lavoro ma anche alla rispettiva situazione all'interno dell'ambiente. Lavorate secondo il concetto di Agile Working? O forse in home office? Grazie alla regolazione in altezza elettrica, SITAGGO 2.0 MINI è in grado di svolgere qualsiasi compito garantendo più movimento e uno stile di lavoro più confortevole.



SITAGGO 2.0 MINI

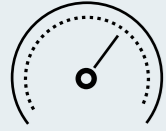

38mm/s

| D | DIE VERSTELLGESCHWINDIGKEIT von 38 mm/s ermöglicht eine komfortable und schnelle Anpassung.
| E | THE HEIGHT-ADJUSTMENT SPEED of 38 mm/s enables fast and convenient adjustments.
| F | LA VITESSE D'AJUSTEMENT de 38 mm/s permet un réglage confortable et rapide.
| I | LA VELOCITÀ DI REGOLAZIONE di 38 mm/s permette di impostare l'altezza desiderata in modo rapido e confortevole.

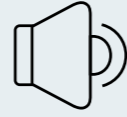

<45 dB

| D | FLÜSTERLEISE Verstellung (unter 45 dB).
| E | WHISPER-QUIET ADJUSTMENT (below 45 dB).
| F | FONCTIONNEMENT EXTRÊMEMENT SILENCIEUX (au-dessous de 45 dB).
| I | REGOLAZIONE SILENZIOSA come un sussurro (< 45 dB).

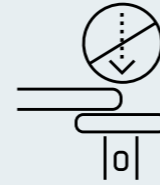

| D | DER AUFFAHRSSCHUTZ erkennt, wenn die Tischplatte auf ein stabiles Hindernis trifft. Die Tischplatte stoppt und fährt in eine sichere Position zurück. Optional kann ein hochsensibler externer Gyro-Sensor eingesetzt werden.
| E | THE COLLISION-PROTECTION FEATURE detects when the tabletop hits a stable obstacle. The tabletop stops and moves back into a safe position. Optionally, a highly sensitive external gyro sensor can be used.
| F | LA PROTECTION ANTI-COLLISION détecte lorsque le plateau de table rencontre un obstacle stable. Le plateau de table s'arrête et revient dans une position sûre. Un capteur gyroscopique externe très sensible peut être utilisé en option.
| I | LA PROTEZIONE ANTI-IMPATTO in salita riconosce quando il piano della scrivania incontra un ostacolo solido. In tal caso il piano arresta la salita tornando in una posizione sicura. In alternativa, è possibile utilizzare un sensore giroscopico esterno ad alta sensibilità.



| D | BELASTBARKEIT bis 20 kg.
| E | LOAD-CARRYING CAPACITY up to 20 kg.
| F | CAPACITÉ DE CHARGE allant jusqu'à 20 kg.
| I | CARICO MASSIMO SOSTENIBILE: 20 kg.



| D | SITAGGO 2.0 MINI passt immer: Zwei Tischplatten-Formen in zwei Größen und drei verschiedene Untergestelle in vier Farben stehen zur Auswahl.

| E | THE SITAGGO 2.0 MINI fits everywhere: two tabletop forms in two sizes and three different bases in four colours are available.

| F | SITAGGO 2.0 MINI convient à tous les usages. Deux formes de plateaux de table en deux tailles et trois piètements différents en quatre couleurs sont disponibles.

| I | SITAGGO 2.0 MINI si adatta sempre a perfezione consentendo di scegliere tra due forme, due misure e tre basamenti diversi di quattro colori.

| D | UNTERGESTELL MIT FUSSPLATTE
 Höhenverstellung 620 – 1080 mm
| E | BASE WITH FOOTPLATE
 Height adjustment: 620 – 1080 mm
| F | PIÈTEMENT AVEC SOCLE
 Réglage de la hauteur 620-1080 mm
| I | BASAMENTO CON PIASTRA DI BASE
 Regolazione altezza nella gamma 620 – 1080 mm

| D | UNTERGESTELL MIT FUSSKREUZ
 Höhenverstellung 640 – 1100 mm
| E | BASE IN CROSS FORM
 Height adjustment: 640 – 1100 mm
| F | PIÈTEMENT EN ÉTOILE
 Réglage de la hauteur 710-1170 mm
| I | BASAMENTO A CROCE
 Regolazione altezza nella gamma 640 – 1100 mm

| D | UNTERGESTELL MIT FUSSKREUZ UND ROLLEN
 Höhenverstellung 710 – 1170 mm
| E | BASE IN CROSS FORM WITH CASTORS
 Height adjustment: 710 – 1170 mm
| F | PIÈTEMENT EN ÉTOILE MONTÉ SUR ROULETTES
 Réglage de la hauteur 710-1170 mm
| I | BASAMENTO A CROCE SU ROTELLE
 Regolazione altezza nella gamma 710 – 1170 mm

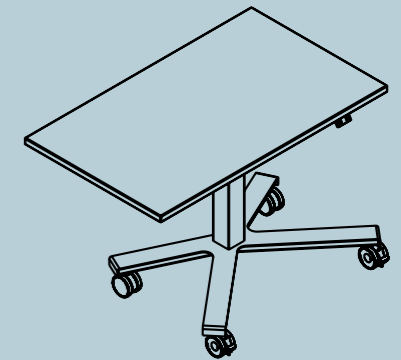
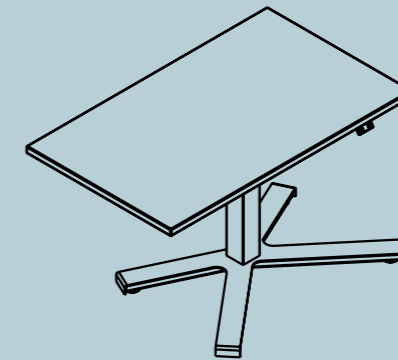
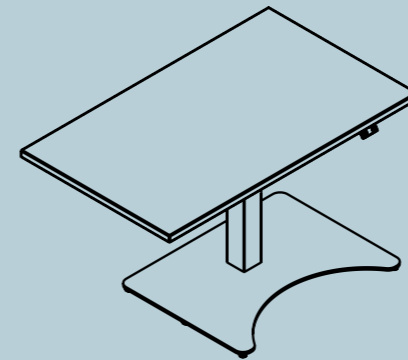

| D | Alle Tischplatten optional auch mit gerundeten Ecken (60 mm Radius).
| E | All desktops are also optional available with rounded corners (60 mm radius).

| F | Tous les plateaux de table peuvent également, en option, avoir des coins arrondis de 60 mm de rayon.

| I | Tutti i piani della scrivania disponibili in via opzionale anche con angoli smussati ad un raggio di 60 mm.



| D | Up/Down Handschalter
| E | Up/down hand switch
| F | Interrupteur manuel haut/bas
| I | Pulsante manuale up/down

| D | Up/Down Handschalter mit Display und Memory-Funktion
| E | Up/down hand switch with display and memory function
| F | Commutateur manuel haut/bas avec affichage et fonction mémoire
| I | Pulsante manuale up/down con display e funzione memoria



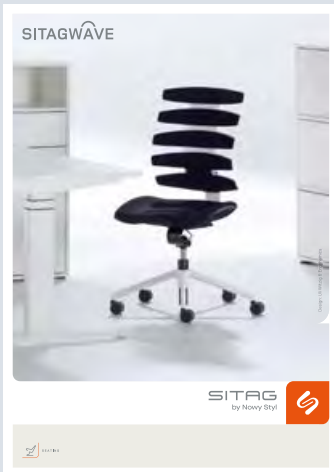
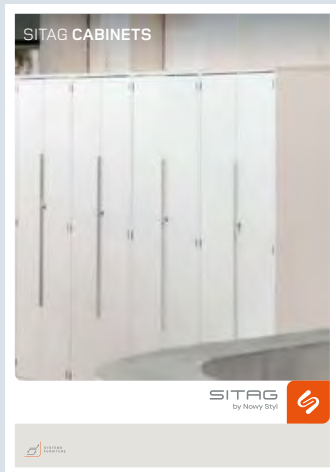
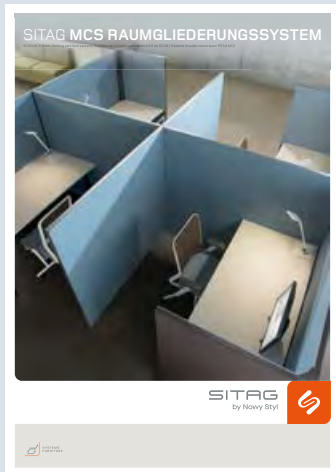
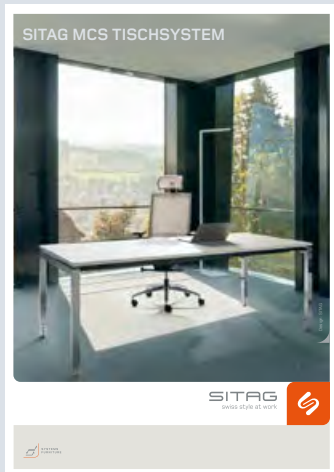
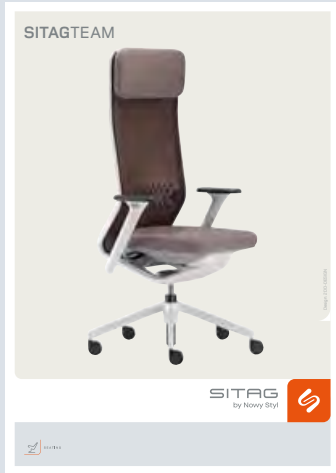
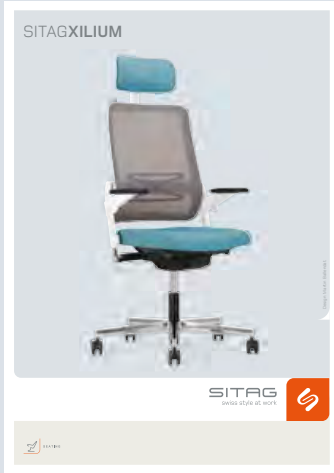

| D | Technische Änderungen, Druckfehler und Programmänderungen vorbehalten. Farbabweichungen von den Originalfarben sind drucktechnisch bedingt.
| E | Subject to technical and programme alterations, printing errors, and other errors. Printed colours may vary from actual colours.
| F | Sous réserve de modifications techniques, d'erreurs d'impression et d'altérations du programme. Les couleurs reproduites peuvent différer des couleurs originales.
| I | Con riserva di modifiche tecniche, errori di stampa e cambiamenti di programma. Eventuali differenze di colore tra le immagini e i prodotti reali sono dovute alla stampa.



SITAG SA Nyon
 Chemin du Joran 10
 CH-1260 Nyon
 T.+41 (0) 22 361 47 27
 info.nyon@sitag.ch

SITAG AG
 Brown-Boveri-Str. 5
 8050 Zurich-Oerlikon
 T +41 44 8637272
 info.zuerich@sitag.ch

Nowy Styl Headquarters
 ul. Pużaka 49
 38-400 Krosno, Poland
 +48 572 900 333
 sales@nowystyl.com

SITAG AG
 Simon Frick-Str. 3
 CH-9466 Sennwald

T +41 (0) 81 758 18 18
 info@sitag.ch
 www.sitag.ch

